

Leptospirosis Relative Risk Estimates based on Continuous-Time, Discrete-Space Stochastic SIR-L-SI Transmission Model

Sufi Hafawati Ideris^{a*}, Norshahida Shaadan^a, Syazreen Niza Shair^a, Nor Azah Samat^b

^aSchool of Mathematical Science, College of Computing, Informatics and Media Univerisiti Teknologi MARA, 40450 Shah Alam, Selangor, Malaysia;

^bDepartment of Mathematics, Faculty of Science and Mathematics, Universiti Pendidikan Sultan Idris, 35900 Tanjong Malim, Perak, Malaysia

Abstract Leptospirosis is a re-emerging global disease that has become endemic in Malaysia. The transmissions usually occur between animals especially rats to rats and rats to humans. Since, it is an easily contractable disease that can be transmitted directly through contact with infected rat's urine or indirectly from the environment such as via water and soil, it is very challenging to curb this disease from infecting humans. Poor understanding of the disease and lack of epidemiological data also made leptospirosis is difficult to control. To cope with this problem, a leptospirosis disease transmission model is developed to study the mechanism of leptospirosis disease spread over continuous-time that may help to predict future caused of an outbreak. This study aims to construct a continuous-time and discrete-space stochastic SIR-L-SI (Susceptible, Infected, Recovered Humans-Leptospire in the Environment-Susceptible, Infectious Rats) of leptospirosis disease transmission to estimate the risk involved. A simple method of asymptotic and numerical analyses is applied as an alternative approach for solving simultaneous differential equations in the leptospirosis SIR-L-SI transmission model. The application of the proposed model is demonstrated using leptospirosis data for Malaysia. The results of asymptotic behaviour and numerical analysis provide useful information about susceptible and infective rat and human populations as well as offer relative risk estimates that can be used as one of the control measures in identifying hot-spot areas for this disease.

Keywords: Leptospirosis, SIR-L-SI model, asymptotic, numerical, relative risk.

***For correspondence:**

2017457104@student.uitm.edu.my

Received: 15 Sept. 2023

Accepted: 4 Dec. 2023

©Copyright Ideris. This article is distributed under the terms of the [Creative Commons Attribution License](#), which permits unrestricted use and redistribution provided that the original author and source are credited.

Introduction

Leptospirosis is an infectious disease that occurs all over the world. In Malaysia, leptospirosis has received attention due to the recent increment number of leptospirosis cases that have alarmed many health professionals [43]. Since 2010, leptospirosis is announced as a notifiable disease in Malaysia that need to be notified within one week to the relevant district health office [42]. This is believe that leptospirosis is still under development process of clinical and epidemiological assessment. Currently, most leptospirosis studies are related to prevalence of leptospirosis and biological reviews regarding the infection of the disease amongst human population such as Lim *et al.* [29], Benacer *et al.* [7], Thayaparan *et al.* [43], Tan *et al.* [42], Garba *et al.* [19] and [20] and Bahaman [4].

Leptospirosis is a contagious disease that may contract in direct and indirect ways [20]. Direct transmission occurs when a host has direct contact with an infectious individual. In contrast,

indirect contact happens via contaminated environment. According to Brauer [9], indirect transmitted diseases require models that include both vectors and hosts and the compartment structure may be different for host and vectors. Infectious rodent population especially rats is the main source of leptospirosis transmission to human population [30]. Direct contact with this animal may cause transmission of leptospires bacteria to susceptible individuals.

However, according to Wynwood *et al.* [46], Minter *et al.* [32] and Cordonin *et al.* [12], most common cause of human infections or major factor of numerous leptospirosis outbreaks in human population is caused by contact of leptospires via contaminated environment. Naturally, rats are nocturnal untamed animal species living in hidden areas and often avoid human being [10]. Thus, human will not simply contract leptospires through direct contact with infectious rats. Environment is a crucial physical junction of leptospires transmission between rat and human. Likewise in rat population, leptospirosis fails to persist in the absence of environmental infection source which is commonly assumed to be the most crucial transmission route [22].

Based on existing model-based studies on the transmission of leptospirosis disease discussed by Ideris *et al.* [22], most of the models do not include specification on the transmission of the disease (such as direct or indirect contact) from infective animals to susceptible humans. Furthermore, the compartmental models were focusing only on transmission between human and rat populations and mostly do not involve free-living leptospires in environment as the transmitting agent. This transmitting agent however is important to develop a certain physical junction of leptospirosis transmission between human and animal populations in order to have realistic models that mimic a true natural infection of the disease. Wynwood *et al.* [47] and Desvars-Larrive *et al.* [17] emphasized that in order to assess or predict leptospirosis risk in human population, it is important to investigate the bacteria in the environment. Based on previous study noticeably the transmission of leptospires element is seems lacking. Hence, this study of leptospirosis disease is conducted to fill up the gap that involves a transmission model between infectious rodents as reservoir and humans as accidental host with extension of environment compartment as generally this indirect transmission requires environment to spread the leptospires pathogen. A leptospirosis transmission SIR-L-SI model is constructed in this study by using continuous time and discrete space data, which commonly used in the analysis of variables that change continuously with respect to time. A simple method of asymptotic analysis is described followed by methods of numerical analysis to obtain approximate solution of these differential equations of SIR-LSI model. The results of analysis provide useful information on human and rat populations change over time and the estimation relative risk for leptospirosis disease.

Materials and Methods

In this study, environment is assumed as an auto-correlate element for the transmission of leptospirosis from rat to human populations. To complete the circle of leptospirosis transmission between rats and humans, a model is proposed that acquire free-living leptospires bacteria from the environment to be included in the SIR-L-SI compartmental model depicted in Figure 1. The compartmental SIR-L-SI model in Figure 1 involves complex interaction between human, rat and environment for the transmission of leptospirosis which represented by boxes and arrows that connect between compartments. Solid arrows refer to movements between the compartments while dotted arrows refer to control signal. The dotted arrow to infected human compartment indicates the transmission of free-living leptospires from contaminated environment shaded in infectious rat's urine into human population. Solid "arrows in" refer to individuals entering the compartment that contribute to the positive sign in the differential equation while the solid "arrows out" refer to individuals exiting the compartment that contribute to the negative sign in the differential equation of deterministic models.

This study examines all behavioural transitions between animal population and environment as well as from environment to human population. In the model, subscripts '*h*' or '*r*' is assigned to each compartment as representative of human and rat populations respectively. From Figure 1, the compartment $S^h(t)$ represents the total number of susceptible persons for leptospirosis for time t , $I^h(t)$ refers to the total number of persons infected with leptospirosis for time t , and $R^h(t)$ is the total number of persons that have recovered from leptospirosis disease for time t . In addition, $S^r(t)$ and $I^r(t)$ represent the total number of susceptible and infective rats for a study location at time t respectively. Meanwhile, compartment L represents free-living leptospires in environment.

The animal hosts namely rats that carry this specific pathogenic leptospires are not harmed themselves [49, 31, 21]. They are also known as natural maintenance hosts. An infected leptospirosis rat will not recover by itself and the leptospires pathogen remains in the animal body until it dies [21]. Thus, unlike humans, the transmission for animal starts with susceptible rat population and ends with infectious cohort of disease transmission.

Furthermore, μ^h represents the birth and mortality rates for human population. Specifically, mortality rate for human populations means persons who leave the group because of natural death or illness like diabetic complications, myocardial infarct, malignancy, motor-vehicle accidents, and other uncorrelated factors with leptospirosis disease. Meanwhile, μ^r represents the birth and mortality rates for rat population, which reflects the number of rats that leave the group because of natural death.

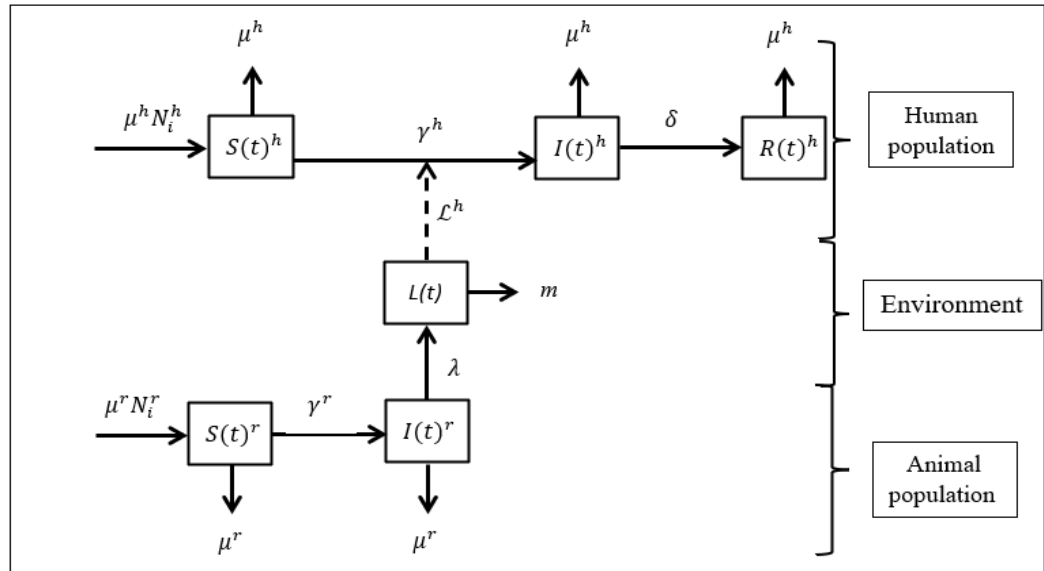

Figure 1. Continuous compartmental SIR-L-SI leptospirosis model for human population, animal population and free-living bacteria in the environment

Meanwhile, N_i^h and N_i^r denote the total population of human and rat, respectively, and recovery rate for human is represented by δ . Next, γ^h represents the rate of leptospirosis transmission from susceptible humans to infected humans while γ^r refers to rate of leptospirosis transmission from susceptible to infected rats. Compartment L is the number of free-living leptospires expressed in shedding units and the existence of compartment L is caused by the shedding of leptospires in the urine of infected rats into the environment. Once susceptible rats have been infected, it will shed units of leptospires (cells per millilitre) denoted as η and other susceptible rats that pass or crawl in those contaminated areas will have the potential to be infected with leptospirosis. Naturally, this route of transmission occurs perpetually among rats. At the same time, humans serve as accidental hosts that contracted leptospires in the environment. This study use a continuous-time approach to study variables that change with time for leptospirosis disease for a particular discrete-space.

First, population is divided into compartments according to their infection states. After the population has been compartmentalized, a set of equations is produced to specify how the sizes of the compartments change with respect to time. According to the compartmental leptospirosis SIR-L-SI model, ordinary differential equations are used where time is the only independent variable indexed by t . These ordinary differential equations have several non-linear equations that need to be solved simultaneously to acquire information on susceptible, infected and recovered populations change over time. It is very difficult to solve these equations analytically. Two methods that can be used to tackle the issue are sophisticated computer programming known as numerical analysis or asymptotic behaviour of solutions as approximations to the actual solution [40]. Hence, this study opts by analysing the problem using asymptotic solutions followed by numerical analyses. Results obtained from these analyses give useful information

about the susceptible, infective and recovered human populations as well as susceptible and infective rat populations.

Differential Equations for SILR-L-SI Model of Leptospirosis Disease Transmission

This subsection provides the formulation of leptospirosis interaction between human, rat and environment. For simplicity, assume that the infection originated from rat population. Based on the compartmental model in Figure 1, the animal population denoted as N^r is subdivided into two compartments; $S^r(t)$ and $I^r(t)$ which represent the total number of susceptible and infective rats. The rat population size is assumed constant all the time as (1).

$$N^r = S^r + I^r \tag{1}$$

The population of susceptible rats increases with rate of birth, μ^r ; of which every birth is assumed susceptible for leptospirosis. At time t , susceptible population decreases following the effective contact with infected rats, $I^r(t)$, denoted as γ^r . Susceptible rat population at time t further decreases by natural death at rate μ^r . In the absence of evidence of disease, birth and death rates are assumed equal and the rate of death μ^r is constant for both subgroups of susceptible and infected rats.

Transmission formula for rat population is constructed when there is an infectious rat in the population, $I^r(0) = 1$ and the initial number of susceptible rats is $S^r(0) = N - 1$. Both $I^r(t)$, and $S^r(t)$ refer to the number of infectious and susceptible rats at time t , respectively. There are two route of infections in rat population; between susceptible and infectious rats and between susceptible rats and contaminated environment. However, only one route is considered in this model to avoid massive calculation in the formula used, which is between susceptible and infectious rats. According to Minter *et al.* [33], this route of transmission is assumed frequency dependent where it is most likely the result of sexual and social contact amongst rats population. Furthermore, constant population assumed previously is parallel with definition of frequency dependent. Therefore, the force of infection, γ^r for infection between susceptible and infectious rats can be defined as in (2).

$$\gamma^r = \frac{\beta^r b^r}{N^r} \tag{2}$$

Where the contact between susceptible rats with infectious rats is written as b^r . Thus, the continuous differential equation for susceptible rats is shown as follows;

$$S^r(t) = \mu^r N_i^r - \frac{\beta^r b^r}{N^r} I^r S^r(t) - \mu^r S^r(t) \tag{3}$$

Next, the population of infectious rats is generated using number of new infections from susceptible rats $S^r(t)$ at rate γ^r . The population of infectious rats decreases by the natural death rate μ^r . The infectious rats formula can be written as (4).

$$I^r(t) = \frac{\beta^r b^r}{N^r} I^r(t) S^r(t) - \mu^r I^r(t) \tag{4}$$

Since infectious rats will be a carrier for their lifetime, the leptospirosis transition for rat population ends at infectious compartment. These infectious rats then excrete their urine in the environment at unit η which contribute to the compartment $L(t)$; free-living leptospires in the environment at time t . This compartment is assumed to have spatio-temporal state that decreases with rate m as it perishes due to survival lost (such as failing to find a host or uncondusive environment).

$$L(t) = \eta I^r(t) - mL(t)$$

which imply that,

$$L(t) = \eta I^r(t) - m(\eta I^r(t))$$

$$L(t) = \eta I^r(t)(1 - m) \tag{5}$$

This leptospires compartment, $L(t)$ in (5) potentially controls the infection on rat as well as human population.

Next, human population denoted by N^h comprises of three components; $S^h(t)$ represents the total number of persons susceptible with leptospirosis with respect to t , $I^h(t)$ refers to the total number of persons infected with leptospirosis at time t , and $R^h(t)$ is the total number of persons recovered from leptospirosis with respect to time, t . Assuming a study in closed population, formula for the human population can be written as in (6).

$$N^h = S^h + I^h + R^h \tag{6}$$

Similar to the differential equations for rat population, number of humans susceptible to leptospirosis increases with rate of birth, μ^h , where every birth is assumed susceptible against leptospirosis. At the same time, the susceptible population decreases following effective contact with free-living leptospires in the contaminated environment, $L(t)$ at rate γ^h .

Rate γ^h is referred to human force of infection in this study of disease transmission modelling. In terms of human transmission, leptospirosis contract structure for this study does not depend on human population size. In this study, the rate of contact that are likely to result in disease transmission is determined by the prevalence of infection between susceptible humans and free-living leptospires in the environment. For instance, the rate of infection depends on how frequent the susceptible individuals being at the high-risk areas or contaminated environment, not protected by personal protective equipment or poor hygiene practices and awareness. Hence, the force of infection model for human population is assumed frequency dependent; increasing with the frequency of potential contact of susceptible humans and free-living leptospires in the contaminated environment. The contact structure is denoted as \mathcal{L}^h defined as the probability for a susceptible human to contact with leptospires in contaminated environment while β^h is the transmission probability of susceptible human via environment.

$$\gamma^h = \frac{\beta^h \mathcal{L}^h}{N^h} \tag{7}$$

Based on equations in (5), compartment L comprises of free-living leptospires in the environment (when the infectious rats excreted their urine in the environment at unit η). To estimate the adequate amount of leptospires pathogen to infect human population, we refer to the minimum unit (cells) of leptospires that is possible to invade a human body (via mucus membrane, broken skin or swollen of contaminated water). According to Haake and Levett [21], quantitative Polymerase Chain Reaction (PCR) test has documented small levels of leptospires (10^4 cells/ml) in infected human bloodstream may be associated with severe complications. This number can increase as high as 10^6 cells/ml or lower than 10^4 cells/ml. Hence, for simplicity, 10^4 cells/ml unit of leptospires burden value is used as a threshold parameter for leptospires measure in human body. In other words, this value determines how much leptospires is required for leptospirosis to infect a human body. Number of free-living leptospires in environment at time t , $L(t)$ divided with 10^4 cells/ml is used to produce ratio of leptospires per susceptible human. Thus, the force of infection rate or probability of susceptible humans being infected is summarised as follows;

$$\gamma^h = \frac{\beta^h \mathcal{L}^h L(t) 10^{-4}}{N^h} \tag{8}$$

Next, susceptible human population further decreases by natural death at rate μ^h . In this model, birth and death rates are assumed equal for simplicity [40]; every day the number of people perish from natural death is equal to the number of people recruited into the susceptible population and the rate of death μ^h is constant for all population subgroups of susceptible, infected and recovered humans. Thus, the differential equation for susceptible humans can be written as (9).

$$S^h(t) = \mu^h N_i^h - \frac{\beta^h \mathcal{L}^h}{N^h} (L(t) 10^{-4}) S^h(t) - \mu^r S^h(t) \tag{9}$$

Next, the population of infected humans is generated using new infection from susceptible humans $S(t)^h$ via free-living leptospires, $L(t)$ in contaminated area at rate γ^h which decreases by natural death rate, μ^h as well as infection recovery at rate δ . Formula for continuous infection to humans can be written as follows;

$$I^h(t) = \frac{\beta^h \mathcal{L}^h}{N^h} (L(t) 10^{-4}) S^h(t) - \mu^h I^h(t) - I^h(t) \tag{10}$$

Individuals in recovery compartment is formulated by the number of newly recovered persons from infected class at rate δ , which decreases by the natural death rate μ^h that is constant for all compartments.

$$R^h(t) = \delta I^h(t) - \mu^h R^h(t) \tag{11}$$

The system of continuous transmission behaviour for leptospirosis disease shown in Figure 1 can be written as non-linear system of differential equations as follow;

$$\frac{dS^h}{dt} = \mu^h N^h - \frac{\beta^h \mathcal{L}^h}{N^h} (L(t) 10^{-4}) S^h(t) - \mu^h S^h(t)$$

$$\begin{aligned}
 \frac{dI^h}{dt} &= \frac{\beta^h \mathcal{L}^h}{N^h} (L(t)10^{-4})S^h(t) - \mu^h I^h(t) - \delta I^h(t) \\
 \frac{dR^h}{dt} &= \delta I^h(t) + \mu^h R^h(t) \\
 \frac{dS^h}{dt} &= \mu^r N^r - \frac{\beta^r b^r}{N^r} I^r(t)S^r(t) - \mu^r S^r(t) \\
 \frac{dI^r}{dt} &= \frac{\beta^r b^r}{N^r} I^r(t)S^r(t) - \mu^r I^r(t) \\
 \frac{dL}{dt} &= \eta I^r(t) - mL(t)
 \end{aligned}
 \tag{12}$$

By using equation in (12), the number of susceptible, infected and recovered individuals in the population can be approximated at each point of time. This model however follows few assumptions. First, infected rats are assumed to not recover from leptospirosis. They will carry the pathogen in their bodies and eventually perish due to the disease or natural death. Second, infected humans are assumed to have recovery or immune phase where the transmission from recovery phase to susceptible phase is not considered in this study since the objectives are accentuated on the disease transmission from susceptible to infected humans. The transmission is assumed to hold until recovery phase. Since this infection takes a short time to develop in human bodies, hence no incubation period is considered. The amount of leptospires pathogen in environment (L) is dependent on the number of infectious rat population; increasing number of infectious rats will increase the amount of free-living leptospires in the environment. Referring to the above equations, existence of products functions clearly define that the system of differential equations is non-linear. Referring to (12), it is hard to solve all six equations involved in a straightforward manner. The next subsections discuss in detail on asymptotic behaviour and numerical analysis to obtain approximate solutions for these differential equations.

Asymptotic Behavior of Solutions for the SIR-L-SI Differential Equations

Asymptotic analysis of solutions gives information about the steady state behaviour of human and rat populations, which depend on threshold value used in epidemiology called R_0 . R_0 is a basic reproduction number most commonly used by epidemiologists to define the average number of secondary infections after introducing a single infective individual in a large susceptible population [39].

Since the model involves demography dynamics (birth and death rates), analysis of equilibrium is important to investigate what happens to the disease in a population in the long term when the system is at equilibrium. If R_0 is less than or equal to 1, the steady state equilibrium values for susceptible and infective that satisfy the condition is given by the point, $E_1 = (1,0,0)$. In the long term, this equilibrium point, E_1 is globally stable if the threshold, R_0 is less than 1. Conversely, when the value of R_0 is greater than 1, the endemic steady state equilibrium values will follow $E_2 = (S^h, I^h, I^r)$ and this equilibrium value is globally stable when R_0 is greater than one.

To approximate the asymptotic behaviour of solutions of the SIR-L-SI non-linear differential equations, two conditions are assumed to hold in this analysis;

$$N^h = S^h + I^h + R^h \quad \text{and} \quad N^r = S^r + I^r \tag{13}$$

where the total human population, N^h and rat population, N^r are supposed to remain constant. Note that this section temporarily modifies the notation to remove the dependency on time considering asymptotic (steady state) behaviour under convergence which is when both human and rat populations remain constant with respect time. In other words, the dynamical change of each population equals to zero;

$$\frac{dN^h}{dt} = 0 \quad \text{and} \quad \frac{dN^r}{dt} = 0$$

Then, differential equations in (12) can be normalized based on the assumption that the size of populations are constant, by considering the proportion as follows;

$$s^h = \frac{S^h}{N^h}, i^h = \frac{I^h}{N^h}, r^h = \frac{R^h}{N^h} \quad \text{and} \quad s^r = \frac{S^r}{N^r}, i^r = \frac{I^r}{N^r} \quad (14)$$

From the proportions in (14), following the conditions in (13), we have;

$$s^h + i^h + r^h = 1 \quad \text{and} \quad S^r + i^r = 1$$

Which imply that

$$r^h = 1 - s^h - i^h \quad \text{and} \quad s^r = 1 - i^r \quad (15)$$

Hence, substitute (14) and (15) into (12) as follows;

$$\begin{aligned} \frac{dS^h}{dt} &= \mu^h - \mu^h s^h - \beta^h \mathcal{L}^h[\eta i^r N^r (1 - m)] 10^{-4} s^h \\ \frac{dI^h}{dt} &= \beta^h \mathcal{L}^h[\eta i^r N^r (1 - m)] 10^{-4} s^h - \mu^h i^h - \delta i^h \\ \frac{dI^r}{dt} &= \beta^r b^r i^r (1 - i^r) - \mu^r i^r \end{aligned} \quad (16)$$

The equilibrium points are found by setting the right-hand side of (16) equal to zero;

$$\frac{dS^h}{dt} = \frac{dI^h}{dt} = \frac{dI^r}{dt} = 0$$

This circumstance is to determine the ultimate number of susceptible and infectives proportions when there is equilibrium or no change over time according to two circumstances as follows;

For the first case, let $i^r = 0$ (where the pathogen suffers from extinction)

$$\begin{aligned} \frac{dS^h}{dt} &= \mu^h - \mu^h s^h - \beta^h \mathcal{L}^h[\eta i^r N^r (1 - m)] 10^{-4} s^h = 0 \\ s^h &= 1 \\ \frac{dI^h}{dt} &= \beta^h \mathcal{L}^h[\eta i^r N^r (1 - m)] 10^{-4} s^h - \mu^h i^h - \delta i^h \\ i^h &= 0 \\ \frac{dI^r}{dt} &= \beta^r b^r i^r - \beta^r b^r i^{2r} - \mu^r i^r \\ i^r &= 0 \end{aligned} \quad (17)$$

The results indicate 1 proportion for susceptible and zero for infective humans and rats respectively. Hence, when the infectious component which is i^r equals to zero, the equilibrium point follows the disease-free equilibrium state $E_1 = (1,0,0)$. According to Esteva and Vargas [18], a disease-free equilibrium point has susceptible numbers of humans or animals but there is zero number of infective cases for both human and animal populations.

The second circumstance is when infectious component, i^r is greater than zero. This indicates persistence of disease in the population. The proportion of susceptible and infectives are calculated as follows;

$$\frac{dS^h}{dt} = \mu^h N^h - \mu^h N^h s^h - \beta^h \mathcal{L}^h[\eta i^r N^r (1 - m)] 10^{-4} s^h = 0$$

so,

$$s^h = \frac{\mu^h N^h}{\mu^h N^h + \beta^h \mathcal{L}^h[\eta i^r N^r (1 - m)] 10^{-4}} \quad (18)$$

Similarly for infectious function,

$$\frac{dI^h}{dt} = \beta^h \mathcal{L}^h[\eta i^r N^r (1 - m)] 10^{-4} s^h - \mu^h i^h - \delta i^h = 0$$

so,

$$i^h = \frac{\beta^h \mathcal{L}^h \mu^h N^h [\eta i^r N^r (1 - m)] 10^{-4}}{(\mu^h + \delta)(\mu^h N^h + \beta^h \mathcal{L}^h[\eta i^r N^r (1 - m)] 10^{-4})} \quad (19)$$

Next, number of infectious rats is calculated as follows;

$$\frac{dI^r}{dt} = \beta^r b^r i^r - \beta^r b^r i^{2r} - \mu^r i^r = 0$$

so,

$$i^r = 1 - \frac{\mu^r}{\beta^r b^r} \tag{20}$$

Hence, when the infectious component is greater than zero, these three values; s^h, i^h and i^r in (18-20) are called endemic equilibrium values and can be written in the form of $E_2 = (s^h, i^h, i^r)$.

After studying the equilibrium points of the leptospirosis disease, the stability of the equilibrium points is determined (since it includes demography factors (birth and death rates) in the infectious transmission model). Equation in (16) is linearized to examine the eigenvalues at each equilibrium of the resulting Jacobian matrix. If all eigenvalues for each equilibrium state have negative real parts, the equilibrium state is locally stable.

Similar with the previous concept of equilibrium state, when the infectious component equals to zero, the local stability of the disease-free equilibrium E_1 is governed by the following matrix;

$$E_1 = \begin{bmatrix} -\mu^h N^h & 0 & -\beta^h \mathcal{L}^h [\eta N^r (1 - m)] 10^{-4} \\ 0 & -\mu^h - \delta & \beta^h \mathcal{L}^h [\eta N^r (1 - m)] 10^{-4} \\ 0 & 0 & -\mu^r + \beta^r b^r \end{bmatrix}$$

The eigenvalues are;

$$\begin{aligned} \lambda_1 &= -\mu^h \\ \lambda_2 &= -\mu^h - \delta \\ \lambda_3 &= -\mu^r + \beta^r b^r \end{aligned}$$

It can be seen that λ_1 and λ_2 have negative real parts.

$$\lambda_3 = -\mu^r + \beta^r b^r = -(\mu^r - \beta^r b^r)$$

While λ_3 have negative real parts if $\beta^r b^r < \mu^r$. Therefore, the disease-free equilibrium point is locally stable for $R_0 < 1$ where $R_0 = \frac{\beta^r b^r}{\mu^r}$.

Meanwhile, when the infectious component is greater than 1, the endemic equilibrium point, E_2 is linearized and governed by Jacobian matrix as follows;

$$E_2 = \begin{bmatrix} -\mu^h N^h - \beta^h \mathcal{L}^h [\eta i^r N^r (1 - m)] 10^{-4} & 0 & -\beta^h \mathcal{L}^h [\eta N^r (1 - m)] 10^{-4} \\ \beta^h \mathcal{L}^h [\eta i^r N^r (1 - m)] 10^{-4} & -\mu^h - \delta & \beta^h \mathcal{L}^h [\eta N^r (1 - m)] 10^{-4} \\ 0 & 0 & -\mu^r + \beta^r b^r (1 - 2i^r) \end{bmatrix}$$

The eigenvalues are;

$$\begin{aligned} \lambda_1 &= -\mu^h - \beta^h \mathcal{L}^h [\eta i^r N^r (1 - m)] 10^{-4} \\ \lambda_2 &= -\mu^h - \delta \\ \lambda_3 &= -\mu^r + \beta^r b^r (1 - 2i^r) \end{aligned}$$

It can be seen that λ_1 and λ_2 have negative real parts.

$$\lambda_3 = \mu^r - \beta^r b^r = -(-\mu^r + \beta^r b^r)$$

While λ_3 have negative real parts if $\beta^r b^r > \mu^r$. Therefore, the endemic equilibrium point is locally stable for $R_0 > 1$ where $R_0 = \frac{\beta^r b^r}{\mu^r}$.

If $R_0 < 1$, the only equilibrium values that satisfy the above condition is given by the point E_1 . Alternatively, if $R_0 > 1$, the endemic equilibrium values follow the point E_2 . Hence, the equilibrium values E_1 and E_2 are globally stable if $R_0 \leq 1$ and $R_0 \geq 1$, respectively.

In conclusion, values of proportion s^h, i^h, r^h, s^r and i^r based on asymptotic behaviour of the solutions of the system SIR-L-SI ordinary differential equations developed in this chapter are presented in (21) below;

$$s^h = \frac{\mu^h N^h}{\mu^h + \beta^h \mathcal{L}^h [\eta i^r N^r (1 - m)] 10^{-4}}$$

$$\begin{aligned}
 i^h &= \frac{\beta^h \mathcal{L}^h \mu^h N^h [\eta i^r N^r (1 - m)] 10^{-4}}{(\mu^h + \delta)(\mu^h N^h + \beta^h \mathcal{L}^h [\eta i^r N^r (1 - m)] 10^{-4})} \\
 r^h &= 1 - s^h - i^h \\
 s^r &= 1 - i^r \\
 i^r &= 1 - \frac{\mu^r}{\beta^r b^r}
 \end{aligned}
 \tag{21}$$

The value of s^h , i^h and r^h represent the proportions of total susceptible, infective and recovered leptospirosis humans daily. Meanwhile, s^r and i^r represent the proportions of susceptible and infective rats. Even though these proportions are only approximate value for the system of ordinary differential equations representing the SIR-L-SI model, it can provide information about the corresponding steady state population counts for S^h , I^h , R^h , S^r and I^r for the continuous time analysis utilized in this study.

Numerical Analysis of Solutions for the SIR-L-SI Differential Equations

The asymptotic analysis of solutions discussed above gives information about the steady state populations for humans (SIR) and rats (SI). Meanwhile, numerical analysis discussed in this subtopic gives useful information about the disease risk estimate. In this study, numerical analysis is a computer-based solution to solve the complex systems of non-linear ordinary differential equations using WinBUGS software came with Bayesian analysis package of prior distributions. Since the SIR-L-SI system of non-linear differential equations is difficult to solve analytically, numerical analysis is applied where finite-time solution is obtained using discrete-time approximation algorithms. To acquire the finite-time solution, continuous-time equations are simplified to stochastic difference equations of discrete-time scale for calculation purposes.

Therefore, the differential equations of continuous-time and discrete-space SIR-L-SI for leptospirosis model is reduced to the following set of difference equations for humans, rats and leptospires in environment in (22).

$$\begin{aligned}
 S_{i,j}^h &= \mu^h N_i^h + \left\{1 - \mu^h - \frac{\beta^h \mathcal{L}^h}{N^h} (L_{i,j-1} 10^{-4})\right\} S_{i,j-1}^h \\
 I_{i,j}^h &= (1 - \mu^h - \delta) I_{i,j-1}^h + \frac{\beta^h \mathcal{L}^h}{N^h} (L_{i,j-1} 10^{-4}) S_{i,j-1}^h \\
 R_{i,j}^h &= \delta I_{i,j-1}^h + (1 - \mu^h) R_{i,j-1}^h \\
 S_{i,j}^r &= \mu^r N_i^r + \left\{1 - \mu^r - \frac{\beta^r b^r}{N^r} I_{i,j-1}^r\right\} S_{i,j-1}^r \\
 I_{i,j}^r &= (1 - \mu^r) I_{i,j-1}^r + \frac{\beta^r b^r}{N^r} I_{i,j-1}^r S_{i,j-1}^r
 \end{aligned}
 \tag{22}$$

and the difference equation for free-living leptospires as follows;

$$L_{i,j} = (1 - m) L_{i,j-1} + \eta I_{i,j-1}^r$$

Based on the deterministic model in (22), the previous continuous-time and discrete-space SIR-L-SI model in (12) is simplified to this set of stochastic difference equations in (23).

For human leptospirosis, $t_{i,j}^h$ = total number of newly infected human with leptospirosis, and $\mathcal{R}_{i,j}^h$ = total number of newly recovered human with leptospirosis,

$$\begin{aligned}
 S_{i,j}^h &= \mu^h N_i^h + S_{i,j-1}^h - \mu^h S_{i,j-1}^h - t_{i,j}^h \\
 t_{i,j}^h &\sim \text{Poisson}(\lambda_{i,j}^h) \\
 \lambda_{i,j}^h &= \left[\exp(\beta_o^h + c_i^h) \right] \left(\frac{\beta^h \mathcal{L}^h}{N^h} L_{i,j-1} 10^{-4} S_{i,j-1}^h \right) \\
 I_{i,j}^h &= (1 - \mu^h) I_{i,j-1}^h + t_{i,j}^h - \mathcal{R}_{i,j}^h \\
 R_{i,j}^h &= R_{i,j-1}^h - \mu^h R_{i,j-1}^h + \mathcal{R}_{i,j}^h
 \end{aligned}
 \tag{23}$$

Due to lack of rat's data, the continuous-time and discrete-space of leptospirosis transmission corresponding to rat population and free-living leptospires in the environment are assumed to be non-stochastic as (24).

$$\begin{aligned}
 S_{i,j}^h &= \mu^h N_i^h + S_{i,j-1}^h - \mu^h S_{i,j-1}^h - t_{i,j}^h \\
 t_{i,j}^h &\sim \text{Poisson}(\lambda_{i,j}^h)
 \end{aligned}
 \tag{24}$$

$$\lambda_{i,j}^h = [\exp(\beta_o^h + c_i^h)] \left(\frac{\beta^h \mathcal{L}^h}{N^h} L_{i,j-1} 10^{-4} S_{i,j-1}^h \right)$$

After developing the transmission mechanism for each compartment, a stochastic model is constructed to provide the approximation of stochastic mean. A stochastic process is a Poisson distribution process with random likelihood that may be analysed statistically but may not be predicted precisely since the process is random (not stationary) and it changes accordingly upon chances. The time interval follows Poisson stationary and independent increment properties ($j-1$ and j), while the study region is i . In this analysis, a random Poisson distribution will be used to generate the probabilities of outcomes of a system called Monte Carlo simulation.

For $i = 1, 2, \dots, M$ study regions and $j = 1, 2, \dots, T$ time periods, the SIR-L-SI model including a probability distribution to reflect the inherent randomness in the data is derived in (23-24). Based on those equations, stochastic element for human population is assigned to the total number of newly infected human with leptospirosis, $\iota_{i,j}^h$ which follows Poisson distribution. The mean for the Poisson distribution is posterior mean number of infective human, $\lambda_{i,j}^{(h)}$ for state i at time j . This mean of Poisson distribution $\lambda_{i,j}^{(h)}$ includes a linear predictor term $\exp(\beta_o^h + c_i^h)$ which include covariates or random effects and a mechanistic model for infection transmission $\left(\frac{\beta^h}{N^h} \cdot \mathcal{L}^h \cdot L_{i,j-1} 10^{-4} \cdot S_{i,j-1}^h \right)$. The main element of transmission equation is the simple direct dependence between susceptible and free-living leptospires counts in a spatio-temporal interaction. The temporal dependence within the model is described by previous free-living leptospires within the same t th state while spatial dependence is assumed to be described by spatial variation for random effect namely conditional autoregressive (CAR) model.

In Bayesian approach, inferences are made based on posterior distribution of relative risk comprises of likelihood function and prior distribution. Modelling for the prior distribution allows spatial dependence between the risk areas. This is due to the geographical, demographical, economy or epidemiological similarities between neighbouring regions. Hence, the value of relative risk estimated of an area is conditional on all other value of risks of its closed regions. The most popular prior distribution used for modelling such spatial structure is intrinsic CAR prior distribution [40]. This prior have been extensively used in spatial statistics to model observed data, unobserved variables and spatially varying random effects [14]. The feature of this CAR model is that the spatial correlation structure is incorporated within the prior distribution for the parameter of interest namely relative risks [28].

Based on the equation (23), β_o^h represents the constant terms to describe the overall rates of the process, and c_i^h represents the random effects that designed to absorb the residual spatial variation for populations. The intrinsic conditional autoregressive (CAR) priors proposed by Besag *et al.* [8] are applied to fit the model for random effects c_i^h where the probability densities of values at any given location are conditional on the neighbouring areas. Next, this stochastic SIR-L-SI model of leptospirosis disease is then applied to relative risks estimate discussed in the next subsection.

Relative Risk Estimation for Disease Transmission

By using Bayes' rule, the combination of observed data and some prior knowledge would produce posterior distribution. In this context, the parameter of interest is posterior mean number of infective individuals, $\lambda_{i,j}$ and data comprises of the total number of newly infectives, $\iota_{i,j}$ for each study region i and time period j . Denote the likelihood of parameter $\lambda_{i,j}$ given the data $\iota_{i,j}$ as $L(\lambda_{i,j}; data)$ and $g(\lambda_{i,j})$ as the joint prior distribution of (λ_{ij}) which provides information about the (λ_{ij}) based upon prior beliefs or assumptions. Consequently, the product of these two components is called the posterior distribution that defined as follows;

$$f(\lambda_{i,j}|data) \propto L(\lambda_{i,j}; data)g(\lambda_{i,j})$$

Let $i = 1, 2, \dots, M$ study region and $j = 1, 2, \dots, T$ time periods, the observation sample used is the pseudo-random sample where λ_{ijk} for $k = 1, 2, \dots, n$ where n is the sample size generated from a posterior distribution for the mean number of leptospirosis infections, $\lambda_{i,j}$. From this sample of the posterior mean number, the posterior expected mean is approximated using the sample below:

$$\tilde{\lambda}_{i,j} = \frac{1}{n} \sum_{k=1}^n \lambda_{ijk}$$

Meanwhile, the respective relative risk parameter is $\theta_{i,j}$ is defined as follows:

$$\text{Relative risk} = \theta_{i,j} = \frac{\text{Posterior mean number, } \lambda_{i,j}}{\text{expected number of new infectives, } e_{i,j}}$$

Based on the equation above, the pseudo-random sample generated for relative risk parameter is approximated as below:

$$\tilde{\theta}_{i,j} = \frac{1}{n} \sum_{k=1}^n \theta_{ijk} = \frac{1}{n} \sum_{k=1}^n \frac{\lambda_{ijk}}{e_{ijk}} = \frac{\tilde{\lambda}_{i,j}}{e_{i,j}}$$

Therefore, the posterior expected relative risk for leptospirosis, $\tilde{\theta}_{i,j}$ can be written as the posterior expected mean number of infections, $\tilde{\lambda}_{i,j}$ over the expected number of new infections, $e_{i,j}$ based on the i th study region.

In this study, the value of relative risk is defined based on research by Samat [41]. A value of relative risk that is equal to zero means people within the study region have no relative risk or infection risk for the disease compared to the people in the population. However, the value of relative risk not ought to be zero since everybody in fact has the possibility or chance of contracting the disease. Next, when the value of relative risk is close to 1 this means that there is no significant difference between the conditional probability that a person in the study region contracts the disease and the conditional probability that a person in the general population contracts the disease.

On the other hand, if the value of relative risk is greater than 1, it indicates that the people within the study region are more likely to contract the disease compared to the people in the population. Conversely, a value of relative risk below 1 indicates a decrease in the likelihood of contracting the disease which means that the people in the study region are less likely to contract the disease compared to people in the population. All the traditional and proposed methods discussed in this study will be applied using WinBUGS software to process leptospirosis data from Malaysia.

Application of Leptospirosis Relative Risk Estimation based on Continuous-Time, Discrete-space Data

This section discusses the application of relative risk estimate for the extension of SIR-L-SI transmission model using continuous-time and discrete-space data from several areas in Malaysia. The data set involved are continuous daily-observed numbers of positive human leptospirosis cases and a data set containing rat samples and number of positive leptospirosis infectious rats for districts in the state of Selangor. Human observed leptospirosis data was obtained from the Ministry of Health Malaysia following approval by the Medical Research and Ethics Committee NMRR-18-3006-43002.

Application of relative risk is approximated corresponding to numerical method in solving the system of non-linear differential equations. Relative risk is the analysis of daily leptospirosis data based on numerical analysis of continuous-time and discrete-space stochastic SIR-L-SI model for leptospirosis transmission. This model analyses data acquired from Ministry of Health Malaysia on daily leptospirosis cases for humans observed continuously from 1st January 2018 to 31st December 2018 for all 9 districts in the state of Selangor. Meanwhile several data set involved in this model are acquired and adapted from previous leptospirosis related studies discussed in the next subsection.

Data Set

Human life expectancy is estimated about 60 years [43]. However, in this analysis, we will use 75 years old according to a press release by Department of Statistics Malaysia. Therefore, the daily birth and death rates for human population is calculated as follows;

$$\mu_d^h = \frac{1}{75 \times 365} = 0.0000365$$

Baca-Carrasco *et al.* [3] estimated the probability contact value for successful transmission of leptospirosis between susceptible humans and contaminated environment or infection rate

between humans and free-living leptospire bacteria, β^h is 4.5×10^{-3} day⁻¹. Next parameter is probability or rate of contact between susceptible humans and contaminated environment by leptospire, \mathcal{L}^h is estimated as 0.525 or 52.5% monthly. Converting this value to daily rate gives \mathcal{L}^h equals to 0.0245.

According to Triampo *et al.* [45], Pongsumpun [36] and Khan *et al.* [27], the recovery duration for human population is 14 days, which corresponds to 0.0714 daily rate as follows;

$$\delta_d^h = \frac{1}{14} = 0.0714$$

For rat population, the birth and death rates are based on one and half year life span of rats [44]. Therefore, the calculation for daily birth and death rates for rat population is calculated as follows;

$$\mu_d^r = \frac{1}{1.5 \times 365} = 0.00183$$

Similar to human population, the value of growth and death rates are assumed balanced, where μ^r equals to 0.00183 per day.

Next, the transmission rate between susceptible and infectious rats resulted in successful transmission of leptospire denoted as β^r is assumed to follow Minter *et al.* [33], where the transmission rate via direct contact between individual rat is 0.09986 per day.

The probability or contact rate happens between susceptible and infectious individuals in the population of rats, b^r via two ways; sexual contact and vertical contact. Through sexual contact or intercourse, leptospirosis male rats may infect female rats and vice versa. Since female rats mate and reproduce frequently in a short period of time [33], there is potential contact with positive leptospirosis male rats. Nevertheless, Minter *et al.* [33] stated that there is low potential of leptospirosis transmission between male and female rats during mating because it is likely that female rats are already infected with the disease as they mature. Most pre-mature rats (either male or female) that already had wounds (from bite or scratches from other rats) on their body had acquired leptospirosis from environment or water. Hence, according to Holt *et al.* [22], coefficient for sexual contact that caused successful transmission of leptospirosis is estimated to be less than 0.01 per day.

Second direct contact is via vertical or perinatal transmission, which is from mother to offspring. Minter *et al.* [32] and [33] stated that the number of pups infected via this method is estimated to be 0.25 per day. The evidence of such transmission among rat individuals is via the presence of leptospire in the semen, milk and mammary gland of rats. Therefore, for simplicity, total contact rate from both sexual and vertical contacts, b^r equals to 0.26 daily.

According to Costa *et al.* [13], for human population, leptospirosis disease is frequently acquired through contact with environment contaminated by leptospire shed in the urine of infected reservoir especially rats. Hence, information on urine shedding loads is crucial to construct mathematical model in this study for estimating human disease risk. According to a study of leptospire in rat urine by Nally *et al.* [34], wild rats can routinely excrete more than 10^6 leptospire per millilitre of urine. Meanwhile, Costa *et al.* [13] in their study estimated the contribution of leptospire shed in the urine for 82 individuals rats to be 9.1×10^{10} cells daily, with a mean of 1.11×10^9 cell/ml leptospire shed to the environment per rat daily. This value seems higher compared to the study by Barragan *et al.* [5] which estimated leptospire quantity per day between 6.1×10^1 to 9.8×10^9 for 53 total rats. Presuming all 53 rats contributed equal quantity of leptospire to the environment; hence, a rat may shed 1.32×10^6 leptospire daily in their urine, a value similar to the one used by Nally *et al.* [35]. Hence, daily contribution of leptospire from infected rat's urine into the environment η is assumed to be 1.32×10^6 cell/ml daily.

Leptospire has high ability of adaption and can survive various environmental conditions in temperate climate (such as soils, swamps, mud, streams and rivers). Leptospire is also able to survive in organs and tissues of live or dead animals [45, 1]. According to Rahmat *et al.* [38], under favourable environmental factors, leptospire are able to survive longer and remain harmful up to 20 months at 30 degree Celsius, 10 months at higher temperature and at least 20 months in acidic environment. However, leptospire will be killed as the temperature increases

more than 50 degree with very low humidity. Furthermore, an analysis of rat-borne by Minter *et al.* [33], estimated lifespan of leptospire to be 20 days as per a study by Casanovas-Massana *et al.* [11]. The ability of the bacteria to persist for months in sufficiently warm and moist environments provides continued opportunities for human infection [34].

In a study of a leptospira species in various water and soil types conducted in Malaysia environment by Munoz *et al.* [34] revealed a longer leptospire survival period of 11 days in river water under shaded areas as compared to in seawater with acidic condition. This leptospira survival period however is different from reported in studies by Casanovas-Massana *et al.* [11] and Rahmat *et al.* [38]. Meanwhile, Bahaman [4] stipulated that leptospire cannot survive for more than a week in the environment but appear to be regularly 'topped-up' by infected urine from infected animals especially rats.

Leptospire survival period in the environment differ between a few hours to several months depending on the species, serovars as well as environmental conditions. However, there is lack of knowledge and poor understanding regarding the abundance and distribution of pathogenic leptospire in the environment [11].

In this study, due to complexity of the issue, estimation of parameters associated with mortality of leptospire, m is assumed not affected by seasonality or climate variables. According to Holt *et al.* [22], in the raining season, leptospire survival is expected to be better as moisture and humidity are greater and water bodies would usually be fresher and cleaner; while in the dry season, shedding of leptospire into water bodies may be high because animals will visit and contaminate those few remaining. A study by Casanovas-Massana *et al.* [11] proved that by considering all seasons, there is no different in leptospire positivity found in the environment. Hence, for this analysis, mortality rate of leptospira, m is assumed constant across all seasons.

Since the study is conducted in Malaysia, hence, mortality rate for leptospire for this study will follow result from Khairani-Bejo *et al.* [26]; surviving 6 days in soil and 11 days in water. For simplicity, lifespan of leptospire in water is chosen since most of the positive human leptospirosis cases are associated with contaminated water bodies [4]. Besides, Holt *et al.* [22] and Costa *et al.* [13] emphasized that water is the most important transmission route via free-living leptospire shed by infected hosts into water surface.

Therefore, the calculation of mortality rate for leptospire is calculated as follows;

$$m_d^r = \frac{1}{11} = 0.091$$

The daily mortality rate for leptospire, m is 0.091 day⁻¹.

Human population size, N^h for the state of Selangor is based on data from Department of Statistics Malaysia website which is 30,840,378 for 2018. The state of Selangor comprises of Sabak Bernam, Hulu Selangor, Kuala Selangor, Gombak, Hulu Langat, Petaling, Klang, Sepang and Kuala Langat denoted as $N_1^h, N_2^h, N_3^h, \dots, N_9^h$ that comprise of 103709, 194387, 251200, 815200, 1370200, 2157000, 1025100, 256900 and 270100 total number of population size respectively.

Considering limited study on the estimate number of rats in Malaysia due to high cost, time constraint, and rats' natural behaviour, this study will simply assume the number of rat population based on ratio by Auerbach [2] where the total number of rats is quarter of total number of humans. Even though it is too simplistic, this assumption at least facilitates for the mathematical modelling of risk estimates in the lack of information on rat population size in Malaysia. To complete the data set for the analysis, infected rats number is approximated based on weightage method. This approximation involves the estimation of total rat population and total infected rats, which is discussed further in Ideris *et al.* [24].

This estimation of data set or variables assumptions involved in this model-based study may influenced by various uncontrolled confounding such as unobserved environmental and covariate factors which difficult to measure. These confounding effects may cause biased in the output results of the analysis. The magnitude of this uncertainty however can be assessed by using sensitivity analysis discussed in section 'Sensitivity analysis of data set'. Sensitivity analysis determines how the output variables are affected by changes in other input variables. Different parameter values are applied and then any changes on result are monitored and recorded.

Results and Discussion for the Application of SIR-L-SI Model

This section discusses results from continuous-time and discrete-space SIR-L-SI leptospirosis transmission model based on non-linear asymptotic and numerical analyses. The asymptotic analysis gives information on the number of susceptible, infected and recovered humans as well as susceptible and infected rats with respect to time. Meanwhile, numerical analysis gives information on the estimates relative high and low-risk for each study location. This information of hot-spot areas is important to prevent potential disease outbreaks.

Application of Asymptotic Analysis of the SIR-L-SI Leptospirosis Transmission Model for Continuous-time and Discrete-space Data

The methodology for describing asymptotic behaviour of solutions for the stochastic SIR-L-SI model of leptospirosis transmission for continuous-time and discrete-space has been discussed in Material and Method section. The application considers s^h , i^h and r^h for humans and s^r and i^r for rats proportions corresponding to the endemic value based on asymptotic behaviour of the SIR-L-SI differential equations solutions in (21). Naively substituting all data and rates related to leptospirosis as discussed in previous 'Data set' section produce solution in term of proportions as follows;

Simply substitute in the relevant formula leads to these proportions for the human population;

$$s^h = 0.01169$$

$$i^h = 15547$$

$$r^h = -15546$$

and proportion for rat population the data are as follows;

$$s^r = 0.0705$$

$$i^r = 0.9295$$

Based on above proportions, the value are clearly infeasible where the proportion for infected human is too large and the proportion of recovered human contributes negative value. This huge number of proportion computed for infected human might be caused by limited information about the data or parameters involved in the transmission model. In addition, higher proportion of infected rats compared to susceptible proportion has contributed to higher infected human proportion. As previously discussed, if $R_0 \leq 1$, then the only equilibrium values that satisfy the above conditions is the disease-free equilibrium point $E_1 = (1,0,0)$. Alternatively, if $R_0 > 1$, then the only equilibrium values that satisfy the above conditions is the endemic equilibrium point $E_2 = (s^h, i^h, r^h, s^r, i^r)$.

In this study, the result of basic reproductive rate, R_0 obtained is 14.18; one case can produce greater average number of secondary cases. The outcome consequently indicates that in the long period, the pathogen is able to invade the susceptible population and leptospirosis disease appears to persist in the Selangor population. Therefore, it can be concluded that the only solution that incorporates the above conditions of R_0 follows the endemic disease equilibrium point shown in proportions s^h, i^h, r^h, s^r and i^r . These asymptotic proportions of solution values for the system of ordinary differential equations of the stochastic SIR-L-SI model lead to the conclusion that the fraction of s^h, i^h, r^h, s^r and i^r of asymptotic solution of endemic disease equilibrium point is (0.01169, 15547, -15546, 0.0705, 0.9295). This threshold behaviour of solution is crucial to determine at what magnitude would be most effective in reducing the leptospirosis disease outbreak.

Since the computation of asymptotic gives an unclear estimate, an alternative approach that is numerical analysis is performed in the next subsection to determine solution for this complicated system of non-linear ordinary differential system.

Sensitivity Analysis of Data Set

In this subtopic, one-way sensitivity analysis is employed to investigate the effects of parameters used in the model on the model output. Each parameter is varied arbitrarily by increasing or decreasing the original rate value to investigate the if there is dynamic change on the SIR graph

for humans and SI graph for rats. In addition, this analysis helps to determine which parameters used are most significant in the variability of the result over time. Since closed population is presumed in this system, death and birth rates are not being considered in this analysis. The parameters involved are successful transmission rate for human and rat populations (β^h and β^r), probability of human contact with free-living leptospires in the environment (\mathcal{L}^h), human recovery rate (δ^h), and probability of contact rate amongst rat population (b^r). Figure 2 displays the basis time series of SIR for human population with the value of rates estimated in "Data set" section.

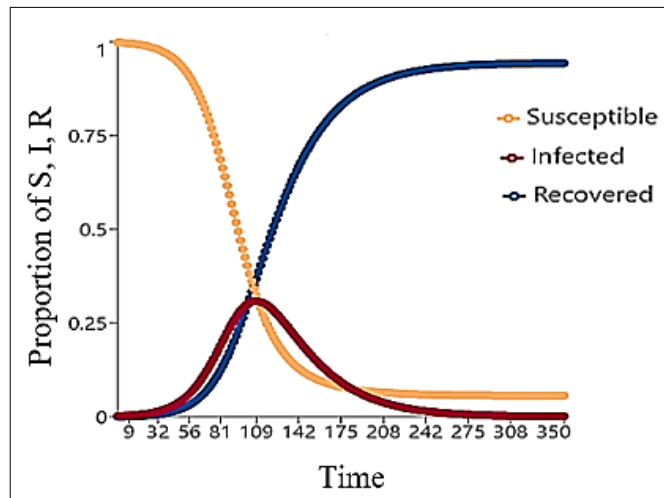

Figure 2. Time series of SIR graph for human with $\mu^h=0.00003649$, $\beta^h=0.005$, $\mathcal{L}^h=0.02$, $\delta^h=0.07$ and $R_0=2.74$

Based on Figures 3 to 8, the initial value of the human classes are $\{S^h(0), I^h(0), R^h(0)\} = \{30840342, 36, 0\}$ and Figures 9 to 13, the initial value of the rat classes are $\{S^r(0), I^r(0)\} = \{7707655, 2439\}$ respectively.

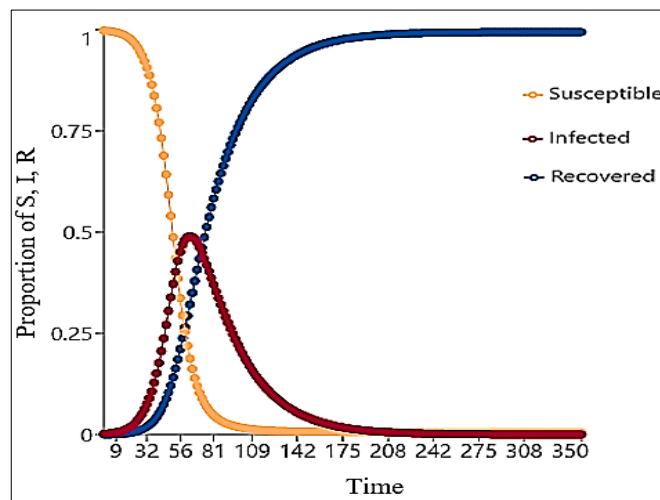

Figure 3. Time series of SIR graph for human with $\mu^h=0.00003649$, $\beta^h=0.009$, $\mathcal{L}^h=0.02$, $\delta^h=0.07$ and $R_0=4.93$

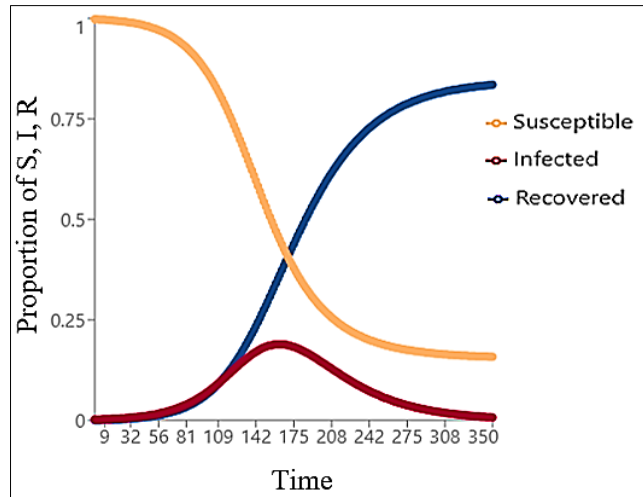

Figure 4. Time series of SIR graph for human with $\mu^h=0.00003649$, $\beta^h=0.004$, $\mathcal{L}^h=0.02$, $\delta^h=0.07$ and $R_0=2.19$

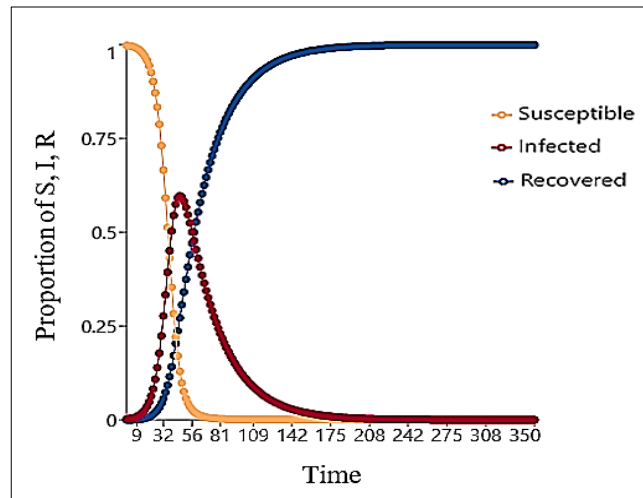

Figure 5. Time series of SIR graph for human with $\mu^h=0.00003649$, $\beta^h=0.005$, $\mathcal{L}^h=0.05$, $\delta^h=0.07$ and $R_0=6.85$

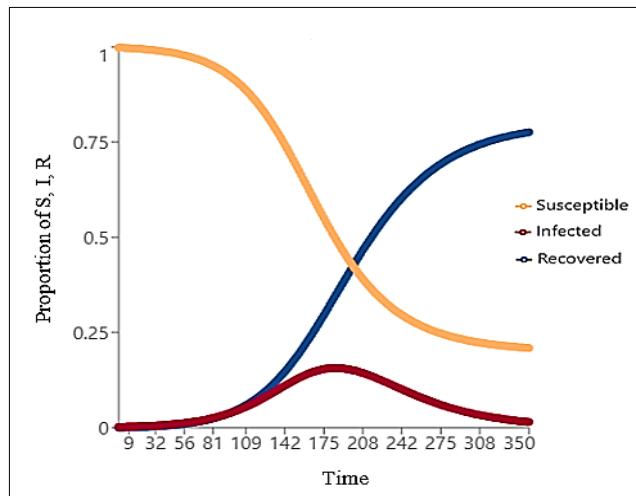

Figure 6. Time series of SIR graph for human with $\mu^h=0.00003649$, $\beta^h=0.005$, $\mathcal{L}^h=0.01$, $\delta^h=0.07$ and $R_0=1.37$

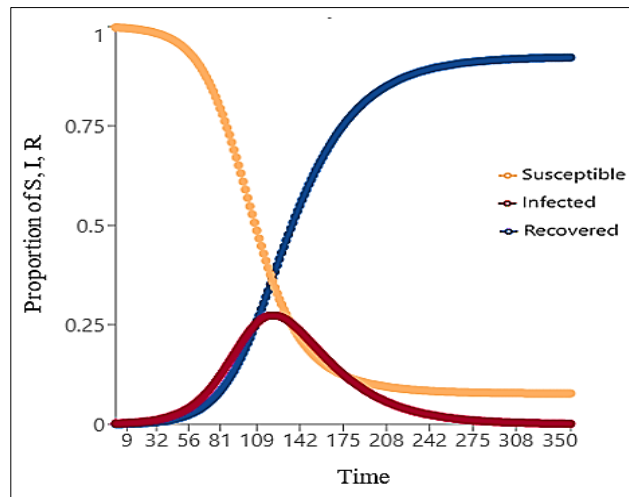

Figure 7. Time series of SIR graph for human with $\mu^h=0.00003649$, $\beta^h=0.005$, $\mathcal{L}^h=0.02$, $\delta^h=0.09$ and $R_0=2.74$

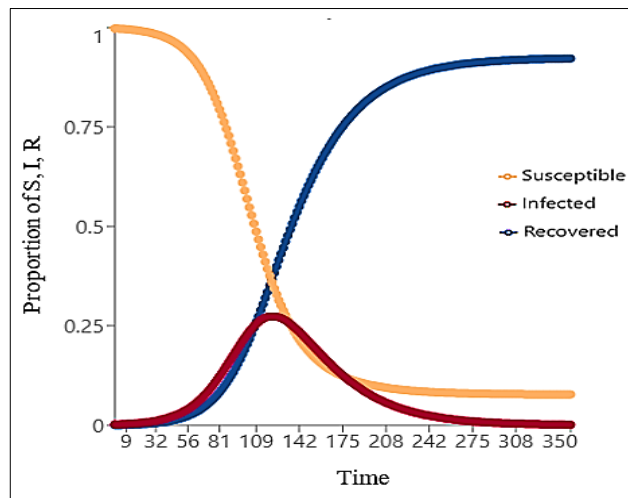

Figure 8. Time series of SIR graph for human with $\mu^h=0.00003649$, $\beta^h=0.005$, $\mathcal{L}^h=0.05$, $\delta^h=0.005$ and $R_0=2.74$

By using Figure 2 as the basis for the analysis, it can be seen that there is significant change of the time series graph in Figure 3 as the rate of β^h increased from 0.005 to 0.009, the susceptible proportion reduced in a short time while infection proportion peaks and drops rapidly compared to when the rate of β^h is reduced displayed in Figure 4. At the same time, the recovery proportion rose early and remain stable. Next, when the contact rate between human being and free-living bacteria in environment \mathcal{L}^h is increased from 0.02 to 0.05, the time series graph in Figure 5 indicates significant changes on susceptible and infected proportions. Susceptible proportion reduced early as the infection proportion peaks very steep compared to Figure. 2 and Figure. 6. Comparing Figures 7 and 8 to Figure 2, increasing or decreasing the value of recovery rate, δ^h does not give significant change on the output of the model. The proportions for susceptible and recovered remained unchanged with a slight changed of infected proportion. Hence, changes on recovery rate, δ^h has no significant impact on the model. For human population, it can be concluded that rate of β^h and \mathcal{L}^h have the most significant effect on the output of the SIR epidemic model. This is evidence by both the value of R_0 and the proportions of the classes at endemic equilibrium point as 350 days' period are considered.

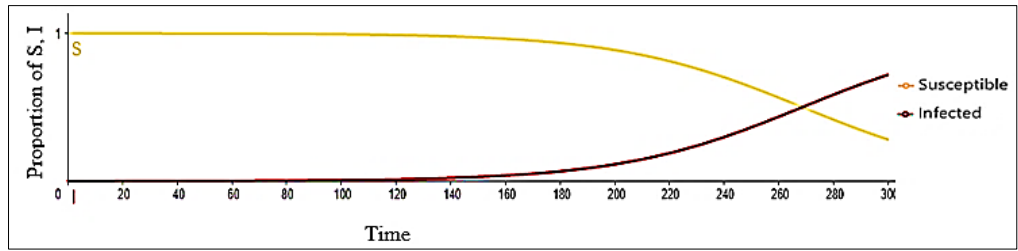

Figure 9. Time series of SI for rat proportion with $\mu^r=0.001831$, $\beta^r=0.1$, $b^r=0.3$ and $R_0=14.18$

Based on Figure 9, the basis time series of SI for rat population is plotted based on the basis value of rates computed in 'Data set' section. For the sensitivity analysis purposes of rat population, only two states involved; susceptible and infective of rats population.

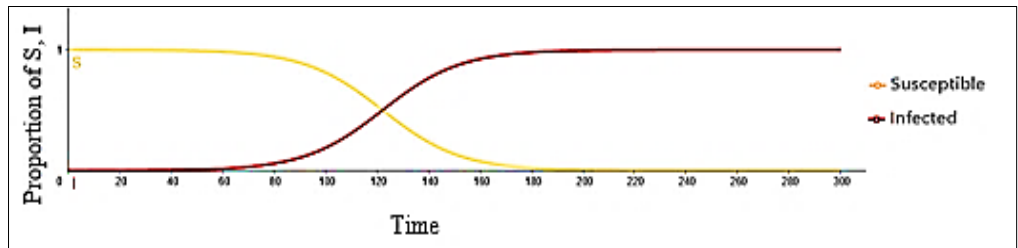

Figure 10. Time series of SI for rat proportion with $\mu^r=0.001831$, $\beta^r=0.3$, $b^r=0.3$ and $R_0=32.8$

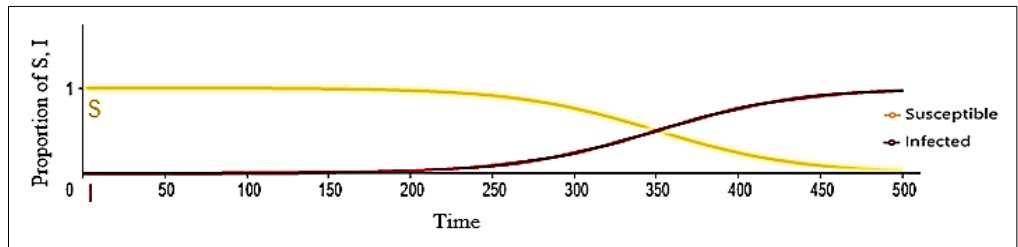

Figure 11. Time series of SI for rat proportion with $\mu^r=0.001831$, $\beta^r=0.05$, $b^r=0.3$ and $R_0=819$

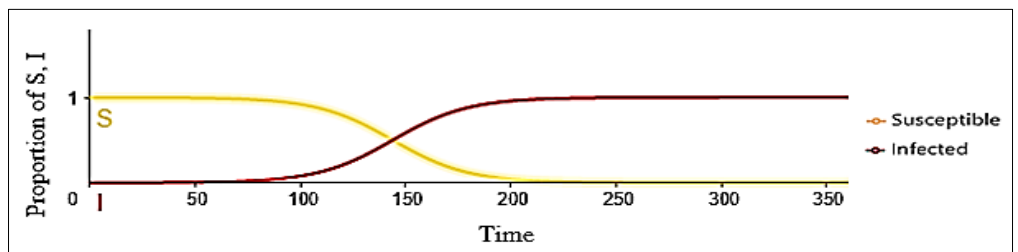

Figure 12. Time series of SI for rat proportion with $\mu^r=0.001831$, $\beta^r=0.1$, $b^r=0.5$ and $R_0=27.3$

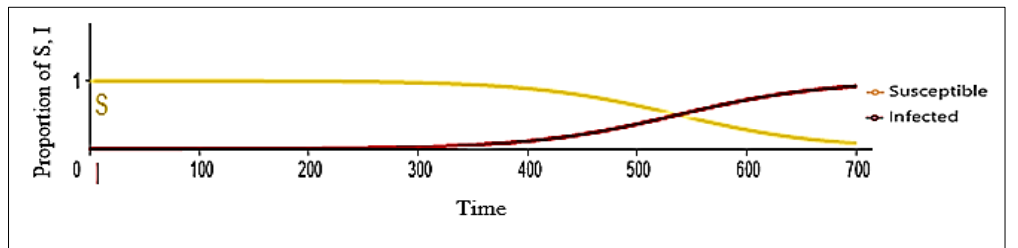

Figure 13. Time series of SI for rat proportion with $\mu^r=0.001831$, $\beta^r=0.1$, $b^r=0.1$ and $R_0=5.46$.

According to Figure 10, as the transmission rate (β^r) is increase from 0.1 to 0.2, the basic reproduction rate, R_0 also increased to 32.8. Susceptible proportion decreased while infectious proportion increased as early as possible. Meanwhile, as the transmission rate reduced from 0.1 to 0.05, the proportions of susceptible rat decreased and infectious rat increased slowly at the same time. Next, comparing Figure 12 and Figure 13 to the basis Figure 9, it is observed to have significant effect on the SI time series graph as increasing or reducing the contact rate value, b^r . Susceptible proportion reduced while infectious proportion increased as early as at 100th day simultaneously when the contact rate, b^r increased from 0.3 to 0.5. Occasionally, as the contact rate between rats is lessen to 0.1, the susceptible proportion decreased and infectious proportion increased even slower which is at 300th day of the study time interval. For sensitivity analysis among rat proportion, both transmission and contact rates are therefore considered to have great significant impact on the output of the epidemic SI transmission model.

As a conclusion from both evidence of basic reproduction number and the proportions, this analysis helps in determining which data set in this transmission model give remarkable changes on the model's output. Thus, a best data set to be careful collected are the ones that give significant on the dynamic transmission model.

Application of Numerical Analysis of the Stochastic SIR-L-SI Leptospirosis Transmission Model

This section demonstrates and displays the results of numerical analysis done on continuous-time, discrete-space data to obtain solutions to the stochastic SIR-L-SI model of leptospirosis disease transmission. The methodology applied to this model is as described in 'Material and Method' section where this approach effectively reduced the continuous-time, discrete-space SIR-L-SI model to a similar form as the discrete-time, discrete-space model in order to solve continuous-time problem as non-linear system of SIR-L-SI ordinary differential equations do not have finite-time solution and unfeasible to solve analytically. The model in this analysis is posterior sampled and is run using WinBUGS 14 software. Figure 2 illustrates time series plots for the daily posterior expected relative risk based on continuous-time, discrete-space stochastic SIR-L-SI leptospirosis disease transmission from 1st January to 31st December 2018 across all nine districts for the state of Selangor.

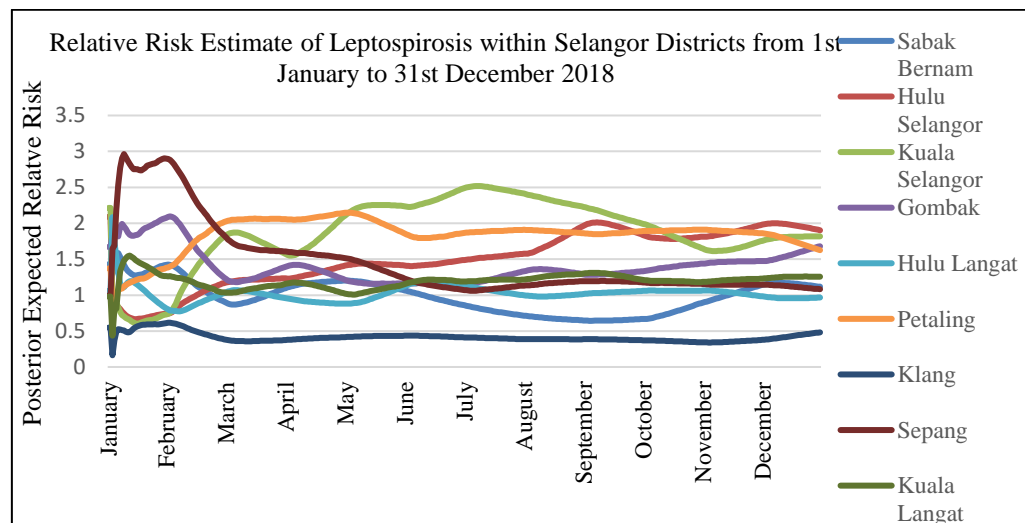

Figure 14. Time series plots of posterior expected relative risk based on continuous-time, discrete-space, stochastic SIR-L-SI model for leptospirosis disease transmission

Based on Figure 14, most of the expected relative risks estimated are less than 3. Klang district is observed to have lowest risk of leptospirosis transmission and infection compared to other districts in Selangor. Next, Sepang had a short highest risk period in the beginning of 2018, which then decreased rapidly through the year. Meanwhile, the risks for Kuala Selangor, Hulu Selangor and Petaling increased significantly in the early period and remained high until December 2018. Generally, from Figure 14 it can be concluded that people in the districts of Kuala Selangor, Hulu

Selangor and Petaling have high-risk contracting leptospirosis disease. Kuala Selangor has a rural setting attributed to agriculture activities such as agriculture and fishery [46]. Based on study by Daud *et al.* [14], environment is a crucial risk factor for infection of leptospirosis—people may be exposed via their occupational activities. Worker in sectors like agriculture, farming and fishery are at high-risk of contracting leptospirosis [14]. Unlike Kuala Selangor and Hulu Selangor, Petaling district is an urban area with highly dense population. As reported by online newspapers MStar Urban Versatil, large number of cases reported in Petaling was caused by unclean environment with improper packaged and disposal of domestic waste by residents and illegal traders. This poor environment management consequently attracted more rats and in turn contributed to rat proliferation.

Table 1. Estimated relative risk on 31st December 2018 of leptospirosis disease based on stochastic SIR-L-SI model

Districts	Relative Risk Estimate for Leptospirosis Disease
Sabak Bernam	1.116
Hulu Selangor	1.904
Kuala Selangor	1.817
Gombak	1.681
Hulu Langat	0.966
Petaling	1.624
Klang	0.483
Selangor	1.084
Kuala Langat	1.255

According to Table 1, relative risk estimates for 31st December 2018 are selected to demonstrate all districts with mostly greater than 1 number of relative risk estimated. This indicates that people within Sabak Bernam, Hulu Selangor, Kuala Selangor, Gombak, Petaling, Sepang and Kuala Langat are more likely to contract the disease compared to the people in the Selangor population. Meanwhile, the conditional probability for people within Hulu Langat and Klang have no significant difference with general population in Selangor to contracts the disease. A report by Dewan Negeri Selangor stated that some cases of human leptospirosis infection in Selangor areas were caused by visiting recreational areas while some of them were exposed to rat’s infestation at home or surrounding areas. The variety of landforms in the state of Selangor such as waterfalls, rivers and tropical forest brings tourists close to the environment. Avocational activities such as hiking, caving, water rafting swimming and camping can cause indirect exposure between human and free-living leptospire bacteria in the surrounding areas, which may be the source of majority outbreak in Selangor [20].

In addition, Hulu Selangor recorded highest risk of leptospirosis during 31st December 2018 followed by Kuala Selangor and Gombak while Hulu Langat has the lowest risk estimated. By zooming or focusing on the output of the relative risks, it can be seen that there are spatial correlations between the neighboring areas. The risk for Hulu Selangor has relatively close with the risks of Kuala Selangor and Gombak since it is located next to each other. This indicates that these models appear to be robust in terms of the covariate element proposed when neighboring areas have relative influence by the high-risk adjacent areas.

Next, a risk map is utilized that displays the risk across the studied region in Figure 15. This information may facilitate the authorities to focus on vulnerable areas as well awareness input for tourist and local resident and consequently prevent from disease outbreak. Figure 15 previews the thematic leptospirosis risk map for relative risk estimated based on continuous-time and discrete space stochastic SIR-L-SI model for leptospirosis disease transmission for 9 districts in Selangor. Based on study by Samat [40] classification of the risk map are grouped into several level of interval which are very low, low, medium, high and very high with the respective intervals of [<0.5), [$0.5-1.0$), [$1.0-1.5$), [$1.5-2.0$) and [$2.0>$]. For the maps previewed, the darkest shaded region represents the area with highest risk while the lightest region indicates the lowest risk area for leptospirosis disease transmission.

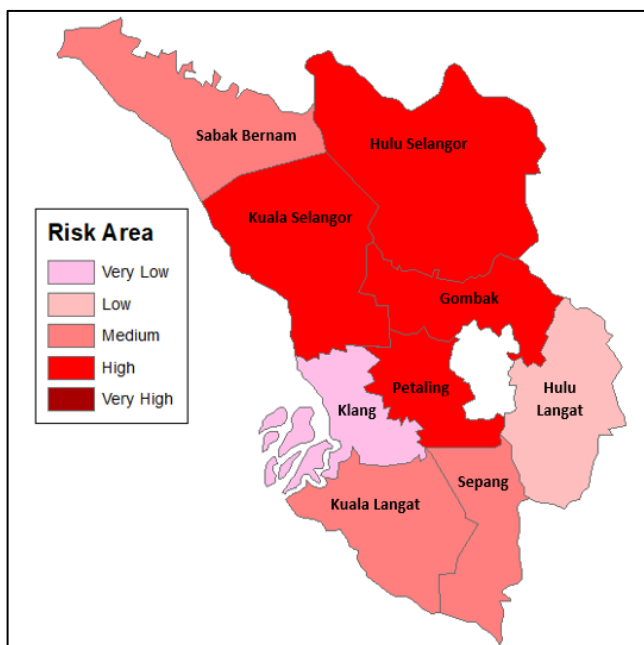

Figure 15. Disease risk map of estimated relative risk based on stochastic SIR-L-SI during 31st December 2018

From Figure 15, it can be seen that the risk is concentrated in the central part of the state. There are no district with very high risk and four districts categorized as high risk and need more attention by authorities which are Hulu Selangor, Kuala Selangor, Gombak and Petaling. Meanwhile, Sabak Bernam, Sepang and Kuala Langat are in medium risk and the other districts are classed as low and very low.

Conclusions and Recommendation

In this study of epidemiology of leptospirosis disease, a model is developed by compiling and analysing data by time, place and population. The traditional epidemiology SIR model is extend to a continuous time and discrete space SIR-L-SI model which involves interaction between human, rat and environment; a complete circle of true common infection route for the leptospirosis disease.

According to the result of the asymptotic and numerical analyses based on the continuous time and discrete space of the SIR-L-SI model, the state of Selangor will have an outbreak as the value of basic reproduction rate computed is greater than 1 in the long run. At the same time, numerical analysis shows that most of the districts also observed to have greater than one relative risk estimated. By applying data from Selangor, these results on asymptotic and numerical analyses are produced to provide useful information on how to solve non-linear system of ordinary differential equations of the SIR-L-SI leptospirosis transmission model. The asymptotic analysis of solutions gives information for the steady state population of human population (SIR) and rat population (SI) in the study region while the numerical analysis of solutions gives information about the SIR and SI populations to estimate relative risks via environment (L). Hence, both methods of solution used in this analysis are significant in solving non-linear continuous-time discrete-space leptospirosis data. Furthermore, risk can be estimate in each study area by using numerical analysis based on stochastic SIR-L-SI model that consequently determine high-risk areas to improve control and ultimately measure to eradicate the leptospirosis infection from human population.

Further application for this continuous time and discrete space SIR-L-SI model is recommended to apply for calibration of the model with the daily case observed in Malaysia that is useful for predicting of future case. Additionally, in the next research this model may be incorporated with other factors that may affect the disease dynamic such as seasonal fluctuation to understand and obtain information of disease pattern for disease control measure.

Conflicts of Interest

The author(s) declare(s) that there is no conflict of interest regarding the publication of this paper.

Acknowledgment

The authors would like to thank and acknowledge the Ministry of Higher Education (MOHE), Malaysia (FRGS/1/2019/ICT05/UITM/02/2) and Research Management Centre (RMC), UiTM (600-IRMI/FRGS 5/3 (388/2019)) for providing the fund to conduct this research.

References

- [1] Al-orry, W., Arahou, M., Hassikou, R., Quasmaoui, A., Charof, R., & Mennane, Z. (2016). Leptospirosis: Transmission, diagnosis and prevention. *International Journal of Innovation and Applied Studies*, 15, 457-467.
- [2] Auerbach, J. (2014). Does New York City really have as many rats as people? *Significance*, 11(4), 22–27. <https://doi.org/10.1111/j.1740-9713.2014.00764.x>.
- [3] Baca-Carrasco, D., Olmos, D., & Barradas, I. (2015). A mathematical model for human and animal Leptospirosis. *Journal of Biological Systems*, 23(supp01). <https://doi.org/10.1142/s0218339015400057>.
- [4] Bahaman, A. R. (2017). Rats and leptospirosis, a unique tropical experience. *Veterinary Research Communications*, 29(1), 26-27
- [5] Barragan, V., Nieto, N., Keim, P., & Pearson, T. (2017). Meta-analysis to estimate the load of Leptospira excreted in urine: Beyond rats as important sources of transmission in low-income rural communities. *BMC Research Notes*, 10(1). <https://doi.org/10.1186/s13104-017-2384-4>.
- [6] Begon, M., Bennett, M., Bowers, R. G., French, N. P., Hazel, S. M., & Turner, J. (2002). A clarification of transmission terms in host-microparasite models: numbers, densities and areas. *Epidemiology and Infection*, 129(1), 147-153. <https://doi.org/10.1017/s0950268802007148>.
- [7] Benacer, D., Thong, K. L., Khebir, V., Galloway, R. L., Hartskeerl, R. A., Lewis, J. W., & Mohd Zain, S. N. (2016). Human leptospirosis in Malaysia: Reviewing the challenges. *Asia Pacific Journal of Public Health*, 28(4), 290-302.
- [8] Besag, J., York, J., & Molli, A. (1991). Bayesian image restoration, with two applications in spatial statistics. *Annals of the Institute of Statistical Mathematics*, 43(1), 1-20.
- [9] Brauer, F. (2012). *Deterministic compartmental disease transmission models*. Lecture. Retrieved April 3, 2016 from http://www.mathualberta.ca/~irl/?summer_school/2012/lecturenotes/det_models.pdf.
- [10] Campi, K. L., & Krubitzer, L. (2010). Comparative studies of diurnal and nocturnal rodents: Differences in lifestyle result in alterations in cortical field size and number. *The Journal of Comparative Neurology*, 518(22), 4491-4512. Doi: <https://doi.org/10.1002/cne.22466>.
- [11] Casanovas-Massana, A., Costa, F., Riediger, I. N., Cunha, M., de Oliveira, D., Mota, D. C., Sousa, E., Querino, V. A., Nery, N., Reis, M. G., Wunder, E. A., Diggle, P. J., & Ko, A. I. (2018). Spatial and temporal dynamics of pathogenic Leptospira in surface waters from the urban slum environment. *Water Research*, 130, 176-184. <https://doi.org/10.1016/j.watres.2017.11.068>.
- [12] Cordonin, C., Turpin, M., Bringart, M., Bascands, J.-L., Flores, O., Dellagi, K., Mavingui, P., Roche, M., & Tortosa, P. (2020). Pathogenic leptospira and their animal reservoirs: Testing host specificity through experimental infection. *Scientific Reports*, 10(1). <https://doi.org/10.1038/s41598-020-64172-4>.
- [13] Costa, F., Wunder, E. A., De Oliveira, D., Bisht, V., Rodrigues, G., Reis, M. G., Ko, A. I., Begon, M., & Childs, J. E. (2015). Patterns in Leptospira shedding in Norway rats (*rattus norvegicus*) from Brazilian slum communities at high risk of disease transmission. *PLOS Neglected Tropical Diseases*, 9(6). <https://doi.org/10.1371/journal.pntd.0003819>.
- [14] Daud, A., Mohd Fuzi, N. M., Wan Mohammad, W. M., Amran, F., Ismail, N., Mokhtar Arshad, M., & Kamarudin, S. (2018). Leptospirosis and workplace environmental risk factors among cattle farmers in northeastern Malaysia. *The International Journal of Occupational and Environmental Medicine*, 9(2), 88-96. <https://doi.org/10.15171/ijjem.2018.1164>.
- [15] De Oliveira, V. (2012). Bayesian analysis of conditional autoregressive models. *Annals of the Institute of Statistical Mathematics*, 64(1), 107-133. <https://doi.org/10.1007/s10463-010-0298-1>.
- [16] Department of Statistics Malaysia Official Portal, "Current Population Estimate, Malaysia. Retrieved September 13, 2021 from https://www.dosm.gov.my/v1/index.php?r=column%2FthemeByCat&cat=155&bul_id=ZjJOSnpJR21sQWVUcUp6ODRudm5JZz09&menu_id=L0pheU43NWJwRWVVSzkiWdzQ4TIhUUT09.
- [17] Desvars-Larrive, A., Smith, S., Munimanda, G., Bourhy, P., Waigner, T., Odom, M., Gliga, D. S., & Walzer, C. (2020). Prevalence and risk factors of Leptospira infection in urban brown rats (*rattus norvegicus*), Vienna, Austria. *Urban Ecosystems*, 23(4), 775-784. <https://doi.org/10.1007/s11252-020-00957-9>.

- [18] Esteva, L., & Vargas, C. (1998). Analysis of a dengue disease transmission model. *Mathematical Biosciences*, 150(2), 131-151. [https://doi.org/10.1016/s0025-5564\(98\)10003-2](https://doi.org/10.1016/s0025-5564(98)10003-2).
- [19] Garba, B., Bahaman, A. R., Khairani-Bejo, S., Zakaria, Z., & Mutalib, A. R. (2017). Retrospective study of leptospirosis in Malaysia. *EcoHealth*, 14(2), 389-398.
- [20] Garba, B., Bahaman, A. R., Bejo, S. K., Zakaria, Z., Mutalib, A. R., & Bande, F. (2018). Major epidemiological factors associated with leptospirosis in Malaysia. *Acta Tropica*, 178, 242-247. <https://doi.org/10.1016/j.actatropica.2017.12.010>.
- [21] Haake, D. A., & Levett, P. N. (2014). Leptospirosis in humans. *Current Topics in Microbiology and Immunology*, 65-97. https://doi.org/10.1007/978-3-662-45059-8_5.
- [22] Holt, J., Davis, S., & Leirs, H. (2006). A model of leptospirosis infection in an African rodent to determine risk to humans: Seasonal fluctuations and the impact of rodent control. *Acta Tropica*, 99(2-3), 218-225. <https://doi.org/10.1016/j.actatropica.2006.08.003>.
- [23] Ideris, S. H., Malim, M. R., & Shaadan, N. (2020). General mathematical transmission model of leptospirosis: A review. *Journal of Critical Review*, 7(13), 2951-2959. <https://doi.org/10.31838/jcr.07.13.455>.
- [24] Ideris, S. H., Shaadan, N., Shair, S. N., Samat, N. A., Mohd-Taib, F. S., Chee, H. Y., Rosli, M. Z., & Wong, P. (2022). Estimation of the rat population and the number of leptospirosis infectious rats via the degree of infectious spatial-temporal weighting (DISTW) method. *2022 Applied Informatics International Conference (AiiC)*. <https://doi.org/10.1109/aic54368.2022.9914588>.
- [25] Keeling, M. J., & Rohani, P. (2008). *Modeling infectious diseases: In humans and animals*. Princeton, UK: University Press.
- [26] Khairani-Bejo, S., A. R. Bahaman, M. Zamri-Saad and A. R. Mutalib. (2004). The survival of leptospira interrogans Serovar Hardjo in the Malaysia environment. *Journal of Animal and Veterinary Advances*, 3,123-129
- [27] Khan, M. A., Ali, Z., Dennis, L. C., Khan, I., Islam, S., Ullah, M., & Gul, T. (2015). Stability analysis of an SVIR epidemic model with non-linear saturated incidence rate. *Applied Mathematical Sciences*, 9, 1145-1158.
- [28] Lawson, A. B. (2006). *Statistical methods in spatial epidemiology* (2nd ed.). Chichester: Wiley.
- [29] Lim, J. K., Murugaiyah, V. A., Ramli, A. S., Abdul Rahman, H., Mohamed, N. S. F., Shamsudin, N. N., & Tan, J. C. (2011). A Case Study: Leptospirosis in Malaysia. (20 December 2011). Retrieved from <http://www.webmedcentral.com/wmcpdf/ArticleWMC002703.pdf>.
- [30] Maas, M., De Vries, A., Reusken, C., Buijs, J., Goris, M., Hartskeerl, R., Ahmed, A., Van Tulden, P., Swart, A., Pijnacker, R., Koene, M., Lundkvist, Å., Heyman, P., Rockx, B., & Van Der Giessen, J. (2018). Prevalence of leptospira spp. and Seoul hantavirus in brown rats (*rattus norvegicus*) in four regions in the Netherlands, 2011-2015. *Infection Ecology & Epidemiology*, 8(1), 1490135. <https://doi.org/10.1080/20008686.2018.1490135>.
- [31] Madhu S, Aparna Y. (2008). Leptospirosis: Epidemiology, diagnosis and control. *J Infect Dis Antimicrob Agents*, 25(4), 93-101
- [32] Minter, A., Diggle, P. J., Costa, F., Childs, J., Ko, A. I., & Begon, M. (2017). Evidence of multiple intraspecific transmission routes for *Leptospira* acquisition in Norway rats (*rattus norvegicus*). *Epidemiology and Infection*, 145(16), 3438-3448. <https://doi.org/10.1017/s0950268817002539>.
- [33] Minter, A., Diggle, P. J., Costa, F., Childs, J., Ko, A. I., & Begon, M. (2018). A model for leptospire dynamics and control in the Norway rat (*Rattus norvegicus*) the reservoir host in urban slum environments. *Epidemics*, 25, 26-34. Doi: 10.1016/j.epidem.2018.05.002.
- [34] Muñoz-Zanzi, C., Mason, M., Encina, C., Astroza, A., & Romero, A. (2014). *Leptospira* contamination in household and environmental water in rural communities in southern Chile. *International Journal of Environmental Research and Public Health*, 11(7), 6666-6680. <https://doi.org/10.3390/ijerph110706666>.
- [35] Nally, J. E., Wilson-Welder, J. H., Hornsby, R. L., Palmer, M. V., & Alt, D. P. (2018). Inbred rats as a model to study persistent renal leptospirosis and associated cellular immune responsiveness. *Frontiers in Cellular and Infection Microbiology*, 8. <https://doi.org/10.3389/fcimb.2018.00066>.
- [36] Pongsumpun, P. (2013). mathematical model for the transmission of leptospirosis in juvenille and adults humans. *International Journal of Mathematical, Computational, Physical, Electrical and Computer Engineering*, 6(12), 1639-1644.
- [37] *Program Kemahiran Teknikal*. Dewan Negeri Selangor. (2013). Retrieved March 9, 2022, from <http://dewan.selangor.gov.my/question/program-kemahiran-teknikal/>.
- [38] Rahmat, F., Zulkafli, Z., Juraiza Ishak, A., Mohd Noor, S. B., Yahaya, H., & Masrani, A. (2020). Exploratory data analysis and artificial neural network for prediction of leptospirosis occurrence in Seremban, Malaysia based on meteorological data. *Frontiers in Earth Science*, 8. <https://doi.org/10.3389/feart.2020.00377>.
- [39] Rodrigues, H. S. (2016). Application of SIR epidemiological model: New trends. *International Journal of Applied Mathematics and Informatics*, 10, 92-97.
- [40] Rodrigues, E. C., Assunção, R. M. (2012). Bayesian spatial models with a mixture neighborhood structure. *Journal of Multivariate Analysis*, 109, 88-102. Doi: 10.1016/j.jmva.2012.02.017.
- [41] Samat, N. A. (2012). Mathematical models for Vector-Borne infectious disease mapping with application to dengue disease in Malaysia (Unpublished doctoral dissertation). University of Salford, Manchester, UK.
- [42] Tan, W. L., Soelar, S. A., Mohd, M. A., Hussin, N., Cheah, W. K., Verasahib, K., & Goh, P. P. (2016). Leptospirosis Incidence and Mortality in Malaysia. *The Southeast Asian Journal of Tropical Medicine and Public Health*, 47(3), 434-40.
- [43] Thayaparan, S., Robertson, I. D., Fairuz, A., Suut, L., & Abdullah, M. T. (2013). Leptospirosis, an

- emerging zoonotic disease in Malaysia. *The Malaysian Journal of Pathology*, 35(2), 123-132.
- [44] Triampo, W., Baowan, D., Tang, I. M., Nuttavut, N., Wong-Ekkabut, J., & Doungchawee, G. (2007). A simple deterministic model for the spread of leptospirosis in Thailand. *International Journal of Medical and Health Sciences*, 2(1), 22-26.
- [45] Triampo, W., Baowan, D., Tang, I. M., Nuttavut, N., Wong-Ekkabut, J., & Doungchawee, G. (2007). A simple deterministic model for the spread of leptospirosis in Thailand. *International Journal of Medical and Health Sciences*, 2(1), 22-26.
- [46] Wasiński, B., & Dutkiewicz, J. (2013). Leptospirosis--current risk factors connected with human activity and the environment. *Annals of agricultural and environmental medicine: AAEM*, 20(2), 239-244.
- [47] Wynwood, S. J., Graham, G. C., Weier, S. L., Collet, T. A., McKay, D. B., & Graig, S. B. (2014). Leptospirosis from water sources. *Pathogen and Global Health*, 108(7), 334-338. Doi:10.1179/2047773214Y.0000000156.
- [48] Zakariya, K., Che Haron, R., Tukiman, I., Ab. Rahman, S. A., & Harun, N. Z. (2020). Landscape characters for tourism routes: Criteria to attract special interest tourists to the Kuala Selangor–Sabak Bernam route. *Planning Malaysia*, 18. <https://doi.org/10.21837/pm.v18i14.843>.
- [49] Zeiman. (2013, June 1). Tikus Timbulkan Masalah Serius Dalam Masyarakat. *MStar Urban Versatil*. Retrieved April 8, 2022, from https://www.mstar.com.my/lokal/semasa/2013/06/01/tikus-timbulkan-masalah-serius-dalam-masyarakat?itm_source=parsey-api.
- [50] World Health Organization. (2003). Human leptospirosis: Guidance for diagnosis, surveillance and control. World Health Organization.